

CENTRAL VAC AND WIRING

Invoice	Qty.	Description
1931 28,799 30Oct20	1	GREAT ROOM: CONDUIT PIPE- FOR TELEVISION- .LOCATE ABOVE FIREPLACE APPROX 66" A.F.F., TERMINATING AT CABLE LOCATION
1931 28,794 30Oct20	1	GREAT ROOM / REC ROOM / BEDROOM 2 / BEDROOM 3: CAT 6 WIRING - ADD CAT 6 OUTLET- SEE PLAN FOR LOCATION PACKAGE PRICE

CERAMIC

Invoice	Qty.	Description
1931 30Oct20 NoCat	1	MAIN FLOOR: FOYER / POWDER / KITCHEN / LAUNDRY: UPGRADE 4 FLOOR TILE - 12X24" LAID IN STRAIGHT, STACKED PATTERN. SEE PLAN FOR TILE DIRECTION
1931 30Oct20 NoCat	1	MASTER ENSUITE: UPGRADE 4 FLOOR TILE - 12X24" LAID IN STRAIGHT, STACKED PATTERN. SEE PLAN FOR TILE DIRECTION
1931 30Oct20 NoCat	1	ENSUITE 2: UPGRADE 4 FLOOR TILE - 12X24" LAID IN STRAIGHT, STACKED PATTERN. SEE PLAN FOR TILE DIRECTION

CONCRETE AND DRAIN

Invoice	Qty.	Description
1931 30Oct20 NoCat	1	3PC BASEMENT ROUGH IN INCLUDED IN APS

DRYWALL

Invoice	Qty.	Description
1931 30Oct20 NoCat	4	.MAIN FLOOR: STANDARD DOOR EXTENDED HEIGHT 96" (PRICE PER DOOR)- MAIN FLOOR
1931 30Oct20 NoCat	3	.MAIN FLOOR; EXTENDED HEIGHT ARCHWAY (PRICE PER DOORWAY) - 96"
1931 30Oct20 NoCat	4	MAIN FLOOR: STANDARD DOOR EXTENDED HEIGHT 96" (PRICE PER DOOR)- MAIN FLOOR
1931 30Oct20 NoCat	3	MAIN FLOOR; EXTENDED HEIGHT ARCHWAY (PRICE PER DOORWAY) - 96"

ELECTRICAL

Invoice	Qty.	Description
1931 28,804 30Oct20	1	GREAT ROOM: 110V WALL RECEPTACLE ON DEDICATED CIRCUIT- LOCATE ABOVE FIREPLACE APPROX 66" A.F.F.
1931 28,819 30Oct20	1	REAR DECK: EXTERIOR:ADD GFI DUPLEX OUTLET WITH COVER - SEE PLAN FOR LOCATION
1931 28,811 30Oct20	1	200 AMP ELECTRICAL SERVICE
1931 28,808 30Oct20	1	KITCHEN: 110V WALL RECEPTACLE ON DEDICATED CIRCUIT - GAS FIRED APPLIANCE - FOR AUX. EQUIPMENT - NOT A STOVE PLUG

FIREPLACE

Invoice	Qty.	Description
1931 30Oct20 NoCat	1	GREAT ROOM: 110V WALL RECEPTACLE ON DEDICATED CIRCUIT- LOCATE ABOVE FIREPLACE APPROX 66" A.F.F.

FORMING

Invoice	Qty.	Description
1931 28,916 30Oct20 **	4	BASEMENT WINDOWS - UPGRADE EXISTING BASEMENT WINDOW TO 30 INCH X 24 INCH - MAY REQUIRE INSTALLATION OF WINDOW WELL

FRAMING

Invoice	Qty.	Description
1931 30Oct20 NoCat	4	MAIN FLOOR: STANDARD DOOR EXTENDED HEIGHT 96" (PRICE PER DOOR)- MAIN FLOOR
1931 30Oct20 NoCat	3	.MAIN FLOOR; EXTENDED HEIGHT ARCHWAY (PRICE PER DOORWAY) - 96"
1931 30Oct20 NoCat	4	MAIN FLOOR: STANDARD DOOR EXTENDED HEIGHT 96" (PRICE PER DOOR)- MAIN FLOOR
1931 30Oct20 NoCat	3	MAIN FLOOR; EXTENDED HEIGHT ARCHWAY (PRICE PER DOORWAY) - 96"

GRANITE MARBLE QUARTZ

Invoice Qty. Description

1931 30Oct20 NoCat	1	KITCHEN: UPGRADE 1 QUARTZ COUNTER
--------------------------	---	-----------------------------------

1931 30Oct20 NoCat	1	KITCHEN; FLUSH BREAKFAST BAR
--------------------------	---	------------------------------

HARDWOOD

Invoice Qty. Description

1931 30Oct20 NoCat	1	MAIN FLOOR: MAIN HALL / LIVING-DINING / GREAT ROOM / LANDINGS: UPGRADE 1 HARDWOOD FLOOR - VINTAGE RED OAK SMOOTH 3/4X4-3/8"
--------------------------	---	---

1931 30Oct20 NoCat	1	UPPER HALL: UPGRADE 1 HARDWOOD FLOOR - VINTAGE RED OAK SMOOTH 3/4X4-3/8"
--------------------------	---	--

HVAC

Invoice Qty. Description

1931 28,872 30Oct20	1	KITCHEN: GAS LINE ROUGH - MAIN FLOOR- (3-STOREY MODELS)
---------------------------	---	---

1931 28,879 30Oct20	1	HUMIDIFIER: WB3 - 1 (3,000+ SQ.FT.)
---------------------------	---	--------------------------------------

INTERIOR TRIM AND DOORS

Invoice Qty. Description

1931 28,883 30Oct20	4	MAIN FLOOR: STANDARD DOOR EXTENDED HEIGHT 96" (PRICE PER DOOR)- MAIN FLOOR
---------------------------	---	--

1931 28,885 30Oct20	3	MAIN FLOOR; EXTENDED HEIGHT ARCHWAY (PRICE PER DOORWAY) - 96"
---------------------------	---	---

KITCHEN AND BATH CABINETRY

Invoice	Qty.	Description
1931 30Oct20 NoCat	1	KITCHEN: PREMIUM SPRAY STAIN
1931 30Oct20 NoCat	2	KITCHEN: POTS AND PANS DRAWERS - 1 SHALLOW TOP DRAWER + 2 DEEP DRAWERS BELOW
1931 30Oct20 NoCat	1	KITCHEN: UPGRADE HARDWARE
1931 30Oct20 NoCat	1	KITCHEN: DELETE UPPERS ABOVE RANGE, FINISH SIDES OF CABINETS - LEAVE APPROX 36" SPACE FOR FUTURE 30" CHIMNEY-STYLE HOOD FAN
1931 30Oct20 NoCat	1	KITCHEN; FLUSH BREAKFAST BAR
1931 30Oct20 NoCat	1	KITCHEN; FLUSH BREAKFAST BAR

PAINT

Invoice	Qty.	Description
1931 30Oct20 NoCat	4	.MAIN FLOOR: STANDARD DOOR EXTENDED HEIGHT 96" (PRICE PER DOOR)- MAIN FLOOR
1931 30Oct20 NoCat	3	.MAIN FLOOR; EXTENDED HEIGHT ARCHWAY (PRICE PER DOORWAY) - 96"
1931 30Oct20 NoCat	1	KITCHEN: PREMIUM SPRAY STAIN
1931 30Oct20 NoCat	4	MAIN FLOOR: STANDARD DOOR EXTENDED HEIGHT 96" (PRICE PER DOOR)- MAIN FLOOR
1931 30Oct20 NoCat	3	MAIN FLOOR; EXTENDED HEIGHT ARCHWAY (PRICE PER DOORWAY) - 96"
1931 30Oct20 NoCat	1	KITCHEN: PREMIUM SPRAY STAIN

PLUMBING

Invoice Qty. Description

1931 28,903 30Oct20	1	KITCHEN; ROUGH-IN - WATERLINE FOR FRIDGE
---------------------------	---	--

1931 30Oct20 NoCat	1	3PC BASEMENT ROUGH IN INCLUDED IN APS
--------------------------	---	--

WINDOWS - BASEMENT

Invoice Qty. Description

1931 28,916 30Oct20	4	BASEMENT WINDOWS - UPGRADE EXISTING BASEMENT WINDOW TO 30 INCH X 24 INCH - MAY REQUIRE INSTALLATION OF WINDOW WELL
---------------------------	---	--

*** NOTE: This is not an approved document. Document must be locked ***

Scheduled Closing Date:

Purchasers: Sulman Ijaz and Arslan Ijaz & Umar Ijaz

Property: 137

Telephone Res. / Bus: (416) 785-5566

Project: Brampton Encore - Phase 2

Decor Advisor: Yolande Somerville

Model and Elevation: 38-6 Elev.B SCARLATTI

Layout Changes: Yes No

Sketch Attached: Yes No

Exterior Colour Scheme:

1. Cabinetry

	Style and Colour	Counter	Hardware
Kitchen / Breakfast	Siena oak *'Graphite'	*Quartz 'Cotton Knit'	*CH-49
Laundry Room	n/a	n/a	n/a
Powder Room	n/a	n/a	n/a
Twin Bath	Siena oak 'Greystone'	P-Lam #Paloma Polar	cs1-24
Master Ensuite Bathroom	Siena oak 'Greystone'	P-Lam #Paloma Polar	cs1-24
Second Ensuite Bathroom (If Applicable)	Siena oak 'Greystone'	P-Lam #Paloma Polar	cs1-24
<input type="text"/>	<input type="text"/>	<input type="text"/>	<input type="text"/>

Comment

2. Floor Tile

	Selection
Entrance Vestibule	*12x24" Eterna London polished 'Imperial Grey'
Main Hall	n/a
Kitchen / Breakfast	*12x24" Eterna London polished 'Imperial Grey' (*not breakfast)
Laundry Room	*12x24" Eterna London polished 'Imperial Grey'
Powder Room	*12x24" Eterna London polished 'Imperial Grey'
Twin Bath	13x13" Costa matte 'white'
Master Ensuite Bathroom	*12x24" Eterna London polished 'Imperial Grey'
Second Ensuite Bathroom (If Applicable)	*12x24" Eterna London polished 'Imperial Grey'
Lower Landing (If Applicable)	13x13" Costa matte 'white' (garage foyer)
<input type="text"/>	<input type="text"/>

Comment

3. Wall Tile

	Selection	Listello/Inserts	Describe
M. Ens Tub skirt/splash	8x10" Weave 'Tender Grey'	<input type="radio"/> Yes <input checked="" type="radio"/> No	<input type="text"/>
Master Ensuite Bathroom			
Tub Deck	8x10" Weave 'Tender Grey'	<input type="radio"/> Yes <input checked="" type="radio"/> No	<input type="text"/>
Shower Stall	8x10" Weave 'Tender Grey'	<input type="radio"/> Yes <input checked="" type="radio"/> No	<input type="text"/>
Bathroom Walls	<input type="text"/>	<input type="radio"/> Yes <input checked="" type="radio"/> No	<input type="text"/>
Second Ensuite Bathroom (If Applicable)	8x10" Weave 'White'	<input type="radio"/> Yes <input checked="" type="radio"/> No	<input type="text"/>
Twin Bath	8x10" Weave 'White'	<input type="radio"/> Yes <input checked="" type="radio"/> No	<input type="text"/>
Kitchen Backsplash	<input type="radio"/> Yes <input checked="" type="radio"/> No	Backsplash Behind Fridge	<input type="text"/>
Comment	<input type="text"/>		

Comment

*see attach #

BE2 - 137
September 11 2020

Scheduled Closing Date:

Purchasers: Sulman Ijaz and Arslan Ijaz & Umar Ijaz Property: 137
 Telephone Res. / Bus: (416) 785-5566 Project: Brampton Encore - Phase 2
 Decor Advisor: Yolande Somerville Model and Elevation: 38-6 Elev.B SCARLATTI

4. Plumbing Fixtures

<input type="checkbox"/>	Second Ensuite	<input type="checkbox"/>	Powder Room	<input type="checkbox"/>
Master Ensuite Bathroom	<input type="checkbox"/>	Other Room - Specify	<input type="checkbox"/>	Other Washroom
		<input type="checkbox"/>		

Comment

Standard Thru out

5. Hardwood Flooring

	Type and Stain		Type and Stain
Main Hall	<input 'graphite'"="" oak="" red="" smth="" type="text" value="*3/4x4-3/8"/>	Upper Landing	<input 'graphite'"="" oak="" red="" smth="" type="text" value="*3/4x4-3/8"/>
Kitchen / Breakfast	<input type="text" value="n/a"/>	Upper Hall	<input 'graphite'"="" oak="" red="" smth="" type="text" value="*3/4x4-3/8"/>
Living Room	<input 'graphite'"="" oak="" red="" smth="" type="text" value="*3/4x4-3/8"/>	Master Bedroom	<input type="text" value="n/a"/>
Dining Room	<input 'graphite'"="" oak="" red="" smth="" type="text" value="*3/4x4-3/8"/>	Bedroom #2	<input type="text" value="n/a"/>
Family Room	<input 'graphite'"="" oak="" red="" smth="" type="text" value="*3/4x4-3/8"/>	Bedroom #3	<input type="text" value="n/a"/>
Den/Library	<input type="text" value="n/a"/>	Bedroom #4	<input type="text" value="n/a"/>
Entrance Vestibule	<input type="text" value="n/a"/>	Bedroom #5	<input type="text" value="n/a"/>
Lower Landing (If Applicable)	<input type="text" value="n/a"/>	Other Room - Specify	<input type="text"/>

Comment

6. Carpeting

	Upgrade	Description
Ground Floor	<input type="checkbox"/>	<input type="text"/>
Second Floor	<input type="checkbox"/>	<input type="text" value="Standard 4002-01 with std u/pad"/>
<input type="text"/>	<input type="checkbox"/>	<input type="text"/>

Upgrade Underpad	Type	Area
	<input type="text"/>	<input type="text"/>
Carpet on Stairs	Capped	Runner - *Upgrade
	<input type="text"/>	<input type="text"/>

Comment

7. Fireplace

	Living Room			Family Room			Other Room - Specify		
	Purchased	As Per Plan	N/A	Purchased	As Per Plan	N/A	Purchased	As Per Plan	N/A
Fireplace Type	<input type="radio"/>	<input type="radio"/>	<input checked="" type="radio"/>	<input type="radio"/>	<input checked="" type="radio"/>	<input type="radio"/>	<input type="radio"/>	<input type="radio"/>	<input checked="" type="radio"/>
Mantle Type	<input type="text"/>			<input type="text" value="Standard Gas"/>			<input type="text"/>		
Colour / Stain	<input type="text"/>			<input type="text" value="NF-20"/>			<input type="text"/>		
Surround	<input type="text"/>			<input type="text" value="White"/>			<input type="text"/>		
Hearth	<input type="text"/>			<input type="text" value="Nero Marquina"/>			<input type="text"/>		
Hearth	<input type="text"/>			<input type="text" value="none"/>			<input type="text"/>		

Comment

BE2 - 137
 September 11 2020
 * see attach *



*** NOTE: This is not an approved document. Document must be locked ***

Scheduled Closing Date:

Purchasers: Sulman Ijaz and Arslan Ijaz & Umar Ijaz Property: 137
 Telephone Res. / Bus: (416) 785-5566 Project: Brampton Encore - Phase 2
 Decor Advisor: Yolande Somerville Model and Elevation: 38-6 Elev.B SCARLATTI

8. Trim Carpentry

Interior Doors Front Door Glass Inserts Door Handles
 Interior Trim
 Comment

9. Plaster Mouldings and Medallions

Standard Throughout Yes No N/A

Entrance Vestibule	<input type="text"/>	<input type="text"/>	Kitchen/Breakfast	<input type="text"/>	<input type="text"/>
Main Hall	<input type="text"/>	<input type="text"/>	Den/Library	<input type="text"/>	<input type="text"/>
Living Room	<input type="text"/>	<input type="text"/>	Lower Landing	<input type="text"/>	<input type="text"/>
Dining Room	<input type="text"/>	<input type="text"/>	Other Room - Specify	<input type="text"/>	<input type="text"/>
Family Room	<input type="text"/>	<input type="text"/>			

Comment

10. Railings and Spindles

Railing Package
 Railing Colour Spindle Colour
 Stringer / Riser Treads
 Oak Stairs Yes No N/A

Comment
 ***Stair stain DOES *NOT* MATCH HARDWOOD FLOORS!!!

11. Wall Paint / Ceilings

Throughout Finished Areas

 Trim Paint
 Smooth Ceilings
 Ground Floor
 Second Floor
 Note

Comment
 See attach

Scheduled Closing Date:

Purchasers: Sulman Ijaz and Arslan Ijaz & Umar Ijaz

Property: 137

Telephone Res. / Bus: (416) 785-5566

Project: Brampton Encore - Phase 2

Decor Advisor: Yolande Somerville

Model and Elevation: 38-6 Elev.B SCARLATTI

12. Electrical

Hood Fan White Stainless N/A

Above Kitchen Cabinet Light Yes No

Below Kitchen Cabinet Light Yes No

Standard Appliances

Over The Range Microwave

Chimney Style Fan

Comment

13. Heating and Air Conditioning

Air Conditioning

Gas Provisions Stove

Gas Provisions Dryer

Gas Provisions Barbecue

Comment

14. Additional Comments

15. Disclaimers and Notes

- 1) Colours of all materials are as close as possible to builder's selection, but not necessarily identical due to variances in manufacturing.
- 2) Any extras listed above are null and void unless accompanied by a separate invoice/amendment. Said invoice must be paid in full.
- 3) The Purchaser acknowledges that after Interior Colour Selection form is signed and dated, no further changes will be permitted other than re-selection due to unavailability. _____ Purchaser's Initials
- 4) The Purchaser acknowledges reading and accepting the "Gold Park Homes Decor Centre Disclaimers" form. This document contains other miscellaneous disclaimers.

This Interior Colour Selection is final and approved by:

Signature: **See attach**

Date: September 11 2020

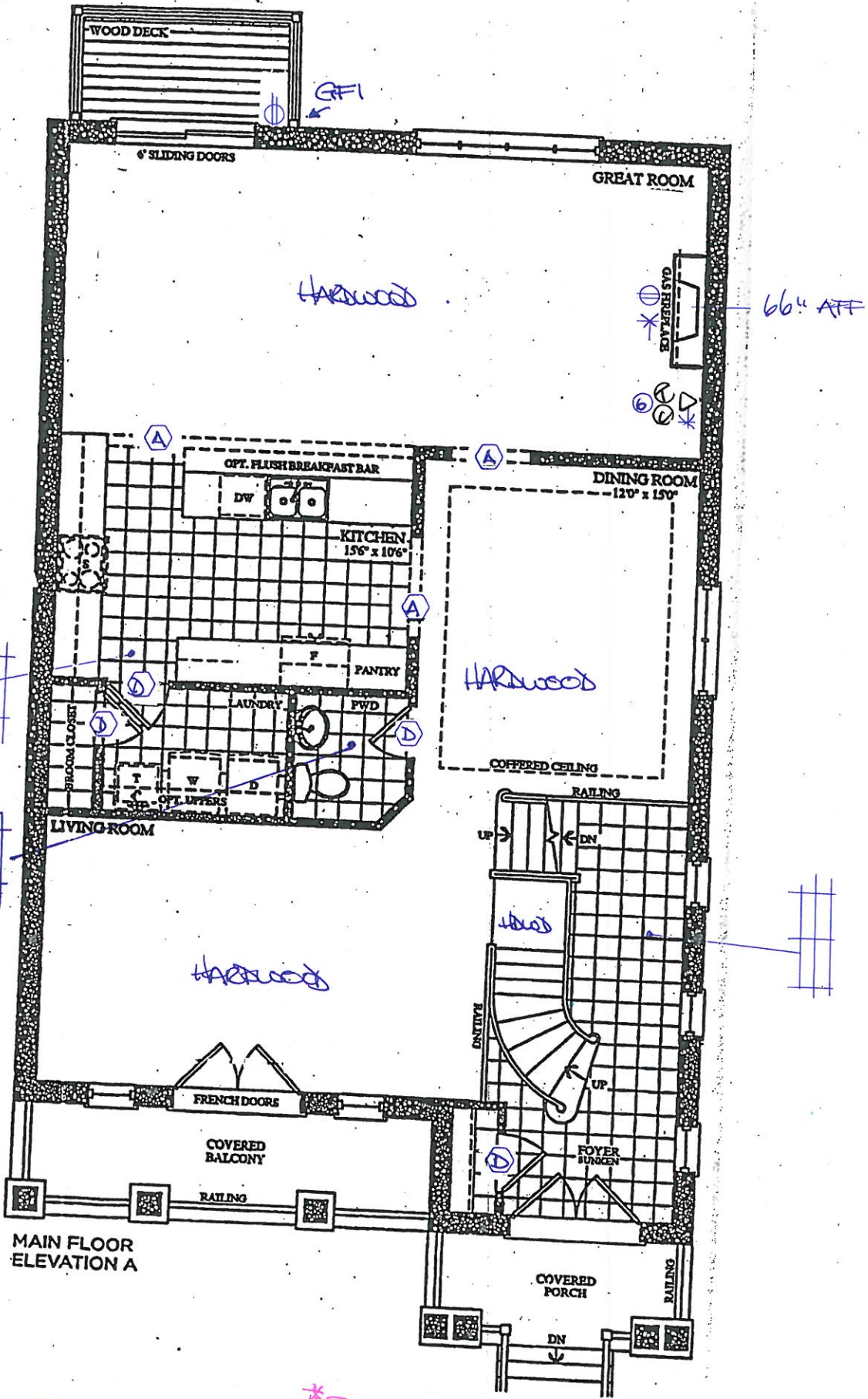

BEZ-137
 September 11 2020

*See
 attach*

The Scarlatti

Elevation A • 3,591 sq.ft. Elevation B • 3,578 sq.ft.

Prices, figures, illustrations, sizes, features and finishes are subject to change without notice. E.A.O.E. Areas and dimensions are approximate and actual usable floor space may vary from the stated area. Layout may be reverse of the unit purchased. E. & O.E.

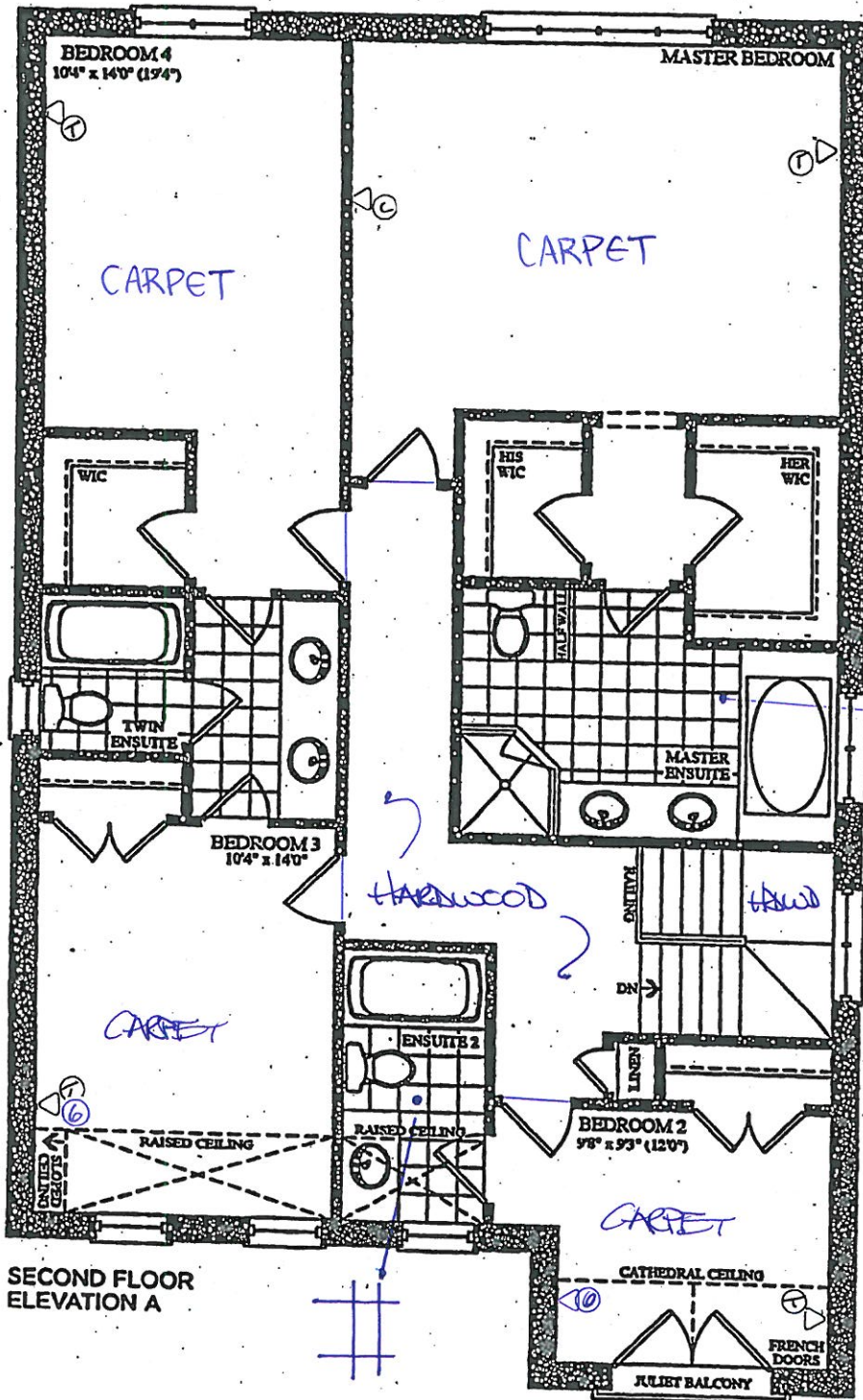

SECOND FLOOR
ELEVATION A

see attach

137

September 11 2020

The Scarlati

Elevation A • 3,591 sq.ft. Elevation B • 3,578 sq.ft.

Prices, figures, illustrations, sizes, features and finishes are subject to change without notice. E.A.G.E. Areas and dimensions are approximate and actual usable floor space may vary from the stated area. Layout may be reverse of the unit purchased. E. & O.E.

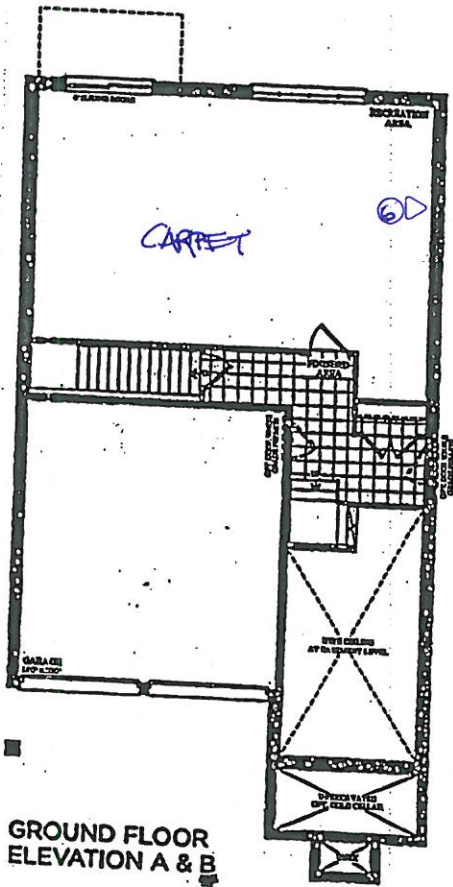

GROUND FLOOR ELEVATION A & B

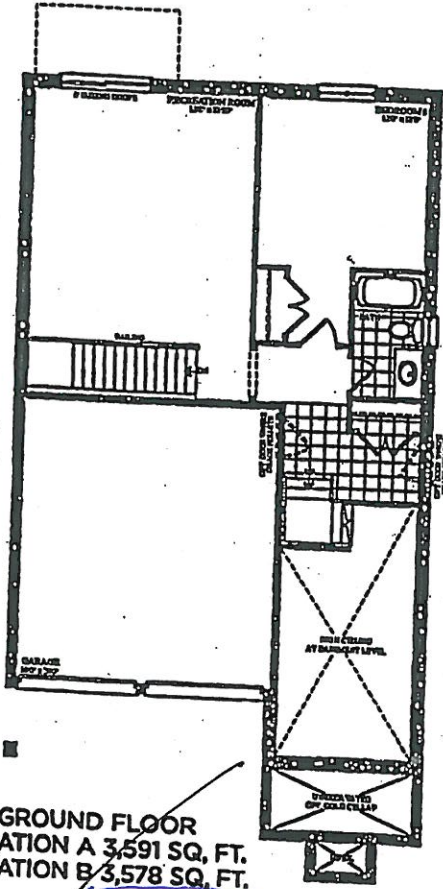

OPT. GROUND FLOOR ELEVATION A 3,591 SQ. FT. ELEVATION B 3,578 SQ. FT.

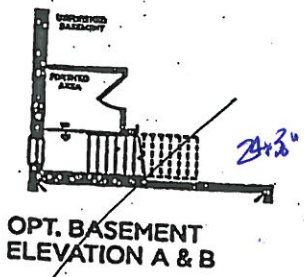

OPT. BASEMENT ELEVATION A & B

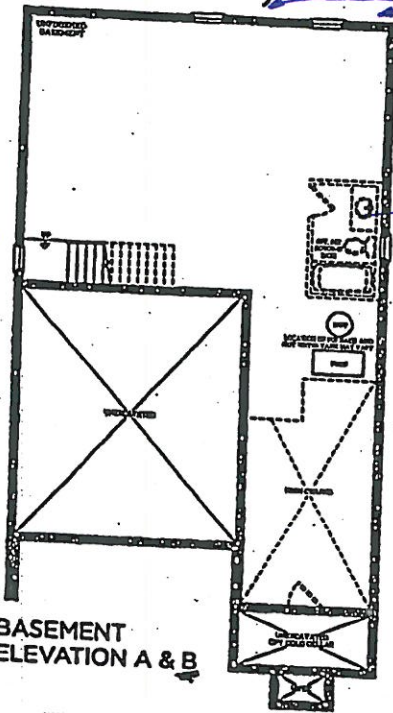

BASEMENT ELEVATION A & B

BE2-137
September 11 2020
see attach

The Scarlatti

Elevation A • 3,591 sq.ft. Elevation B • 3,578 sq.ft.

Prices, figures, illustrations, sizes, features and finishes are subject to change without notice. E.&O.E. Areas and dimensions are approximate and actual usable floor space may vary from the stated area. Layout may be reverse of the unit purchased. E. & O.E.

Trade Name: Gold Park Homes	Site location: Brampton	Model: 38-6
Address:	Project: Encore	Phase:

This layout has been explained to the purchaser by Cortina Kitchens Inc. and is understood by the purchaser.

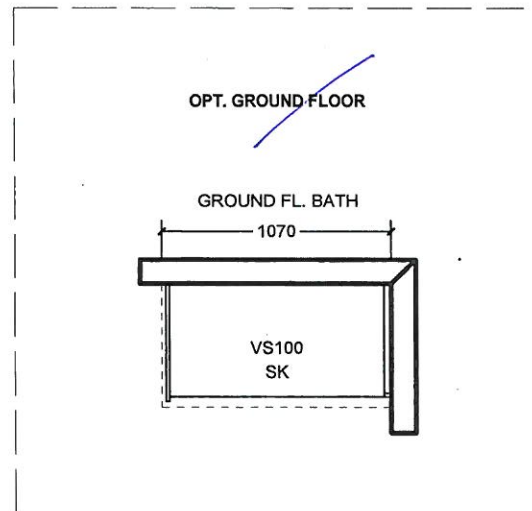
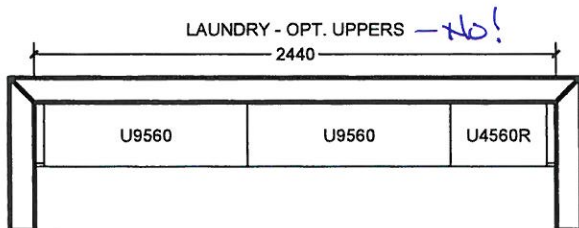
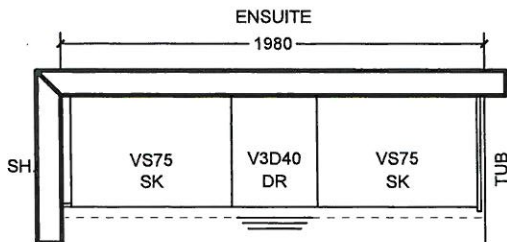
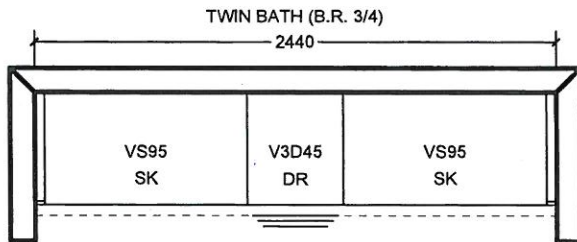
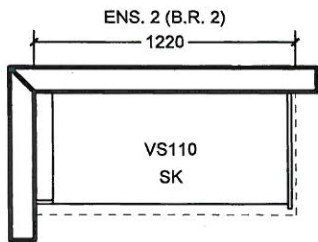
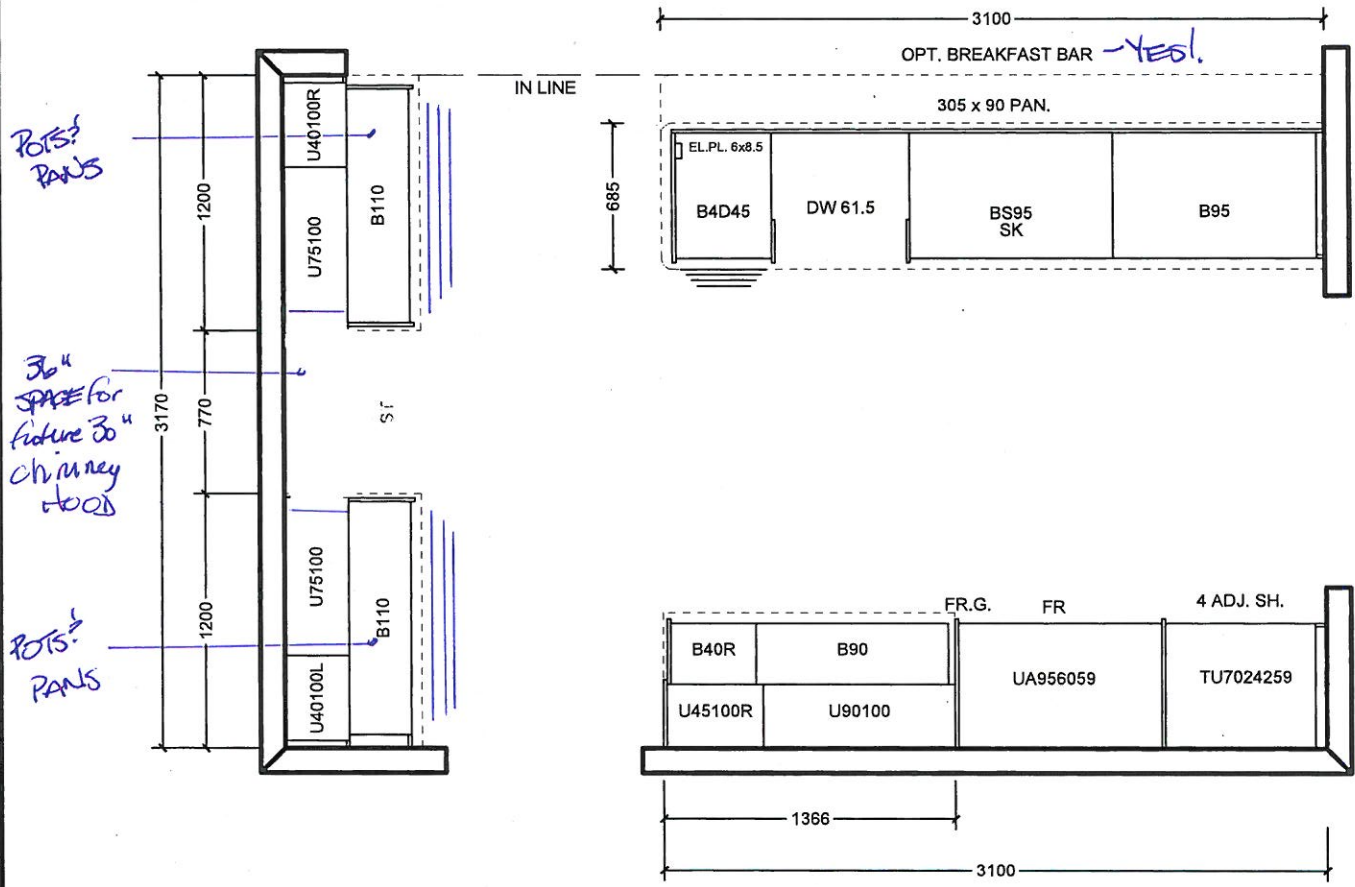

All prices subject to confirmation from head office. This quotation is subject to the terms & conditions set out in Cortina's Agreement of Purchase and Sale

All agreements are contingent upon strikes, accidents, and delay beyond our control. Please provide our Installer with template for sinkholes or \$150.00 will be charged for callback.

ACCEPTED DATE: _____

CUSTOMER SIGNATURE

SALESPERSON SIGNATURE

CORTINA HEAD OFFICE APPROVAL

ITEM A. Wood grain and colour are characteristics of the product, we cannot guarantee that such grain and colour will always match
ITEM B. Cortina Kitchens reserves the right to alter dimensions and make technical changes without notice.

- Standard 2CM & 3CM
- Upgrade 1 2CM & 3CM
- Upgrade 1 4 CM
- Upgrade 2

20mm (3/4") Profiles

- FE 20
- C20
- H20
- F20
- IL20
- B20

30mm (1 1/4") Profiles

- FE30
- H30
- C30
- T30
- Z30
- B30
- VB30
- FV30
- VX30
- FZ30

40mm (1 1/2") Profiles

- FE40
- H40
- Z40
- DR40
- T40
- C40
- B40
- MITER
- FV40
- VX40
- FFZ40
- LZ40
- VB40
- FZ40

BE2-137
September 11 2020
* see attach *

KITCHEN
+
MASTER +
ELEM 2 +
TWIN

Note: All colours may not be available in 30mm at time ordered. Vendor reserves the right to use 40 mm edges (by lamination process).

*Mitre edge is available in Upgrade 1 for an overall thickness of 2". All other Mitre edge options will be an Upgrade 2 Edge.

BEZ-137
September 11 2006
* See attach *



CSI-6



CSI-10



CSI-14

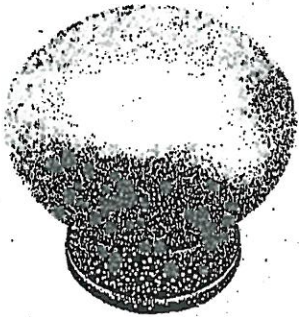

CSI-16

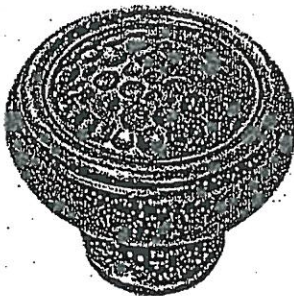

CSI-18

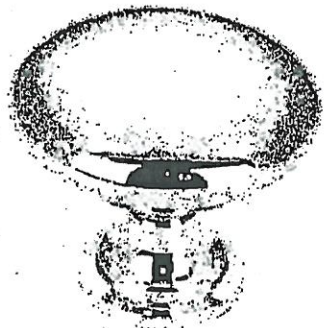

CSI-19



CSI-20



CSI-21



CSI-22

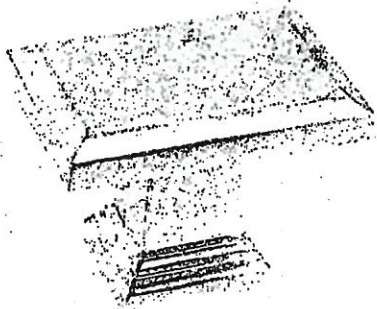

CSI-23

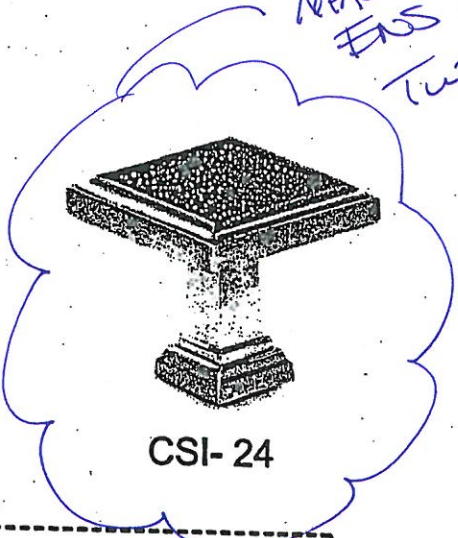

CSI-24

MASTER +
EWS 2+
TWIN

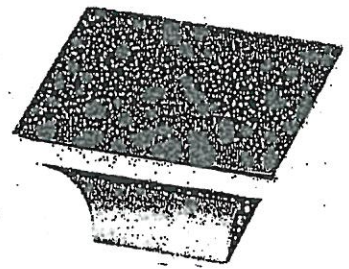

CSI-25

***NOTES:**
- IMAGES ARE FOR QUICK REFERENCE PURPOSES ONLY
- ACTUAL SIZES AND FINISHES AS PER HARDWARE
- SAMPLE BOARD PROVIDED TO DECOR CENTRE

FE2-137
September 11 2020

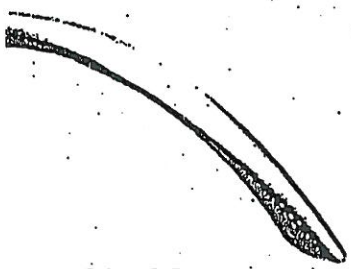

CH-32

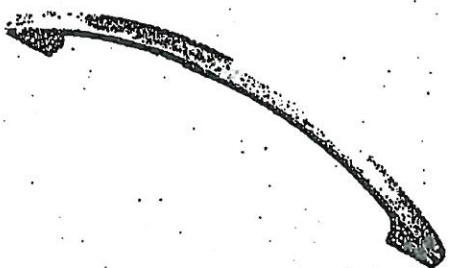

CH-38

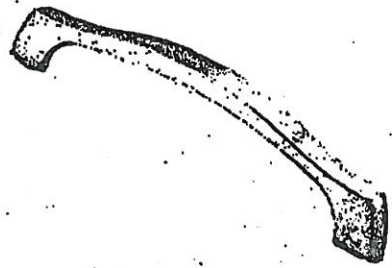

CH-44

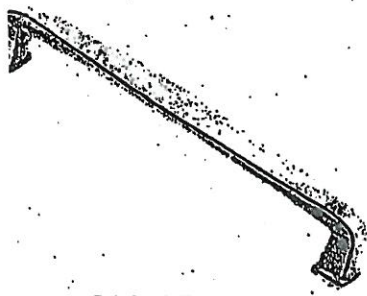

CH-45

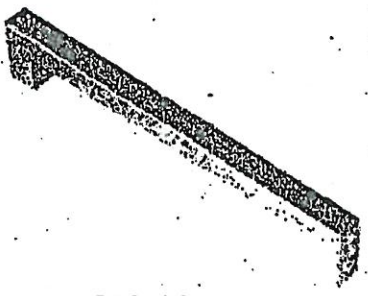

CH-46

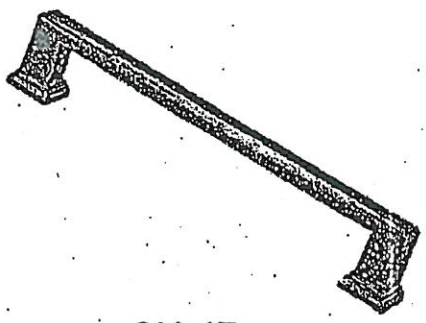

CH-47

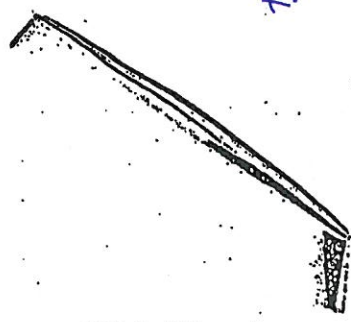

CH-48

KTINA

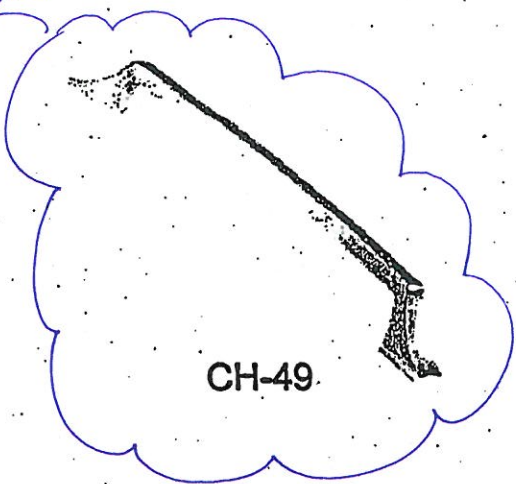

CH-49



CH-50

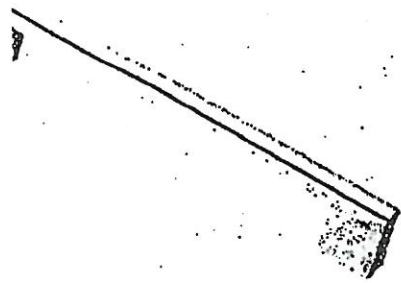

CH-51

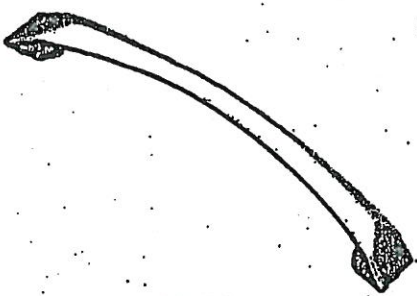

CH-52

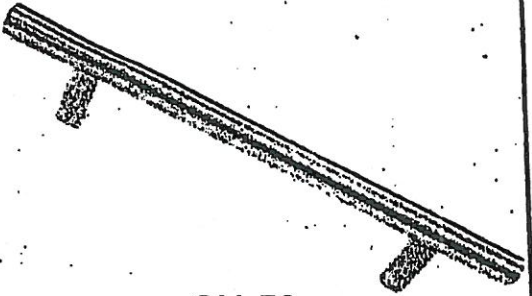

CH-53

NOTES:
IMAGES ARE FOR QUICK REFERENCE PURPOSES ONLY
ACTUAL SIZES AND FINISHES AS PER HARDWARE
AMPLE BOARD PROVIDED TO DECOR CENTRE

Gold Park Homes Décor

GOLDPARK
WORTH MORE™

Centre Disclaimers

Through years of doing business, we at Gold Park Homes have encountered issues beyond our control. The following disclaimers apply to all instances of Purchaser's Extras forms and all Interior Colour Scheme forms.

FIREPLACES

Fireplace Marble: Due to the many variables that can affect the pattern and/or design, frequently the marble installed on the fireplace will not be identical to the samples. We will make every attempt to come as close to the samples as possible, but cannot be responsible for results which differ from the samples.

CERAMIC FLOOR TILE

Many variables including variegation can affect tile colour, pattern and/or design which mean installed tiles may not be identical to the samples. We will make every attempt to come as close as possible, but cannot be responsible for results which differ from the samples.

HARDWOOD FLOORING

The purchaser is advised that cupping and shrinkage are characteristics of hardwood flooring normally appearing after installation, especially when humidity levels are not regulated, and no warranty is provided by the flooring supplier with respect to such cupping and shrinkage. Furthermore, hardwood floors may also heave and warp when located at or close to entrance points of the home, where rain could make its way to the flooring. The vendor agrees to install any hardwood flooring ordered by the purchaser in a good and workmanlike manner, but shall not be responsible for, and is hereby released by the purchaser from responsibility and liability for cupping, shrinkage, heaving and warping of hardwood flooring in the above mentioned circumstances.

STAIRCASE VS FLOORING WOOD SPECIES DIFFERENCE

The purchaser is aware and therefore accepts and acknowledges that the wood species of the staircase and flooring chosen do not match. This difference might result in an undesirable colour variance.

The purchaser is aware and therefore accepts and acknowledges that though the flooring is of the same species as the staircase the difference in product finishing may result in a stain colour variance.

The purchaser agrees that the vendor is to be exempt from any and all claims by the purchaser regarding this colour variance.

RAILINGS

All railings, pickets, posts, nosing's and stairs come from solid wood and veneered wood materials sourced from multiple locations and sources. As such there will be variations in grains and shades between the various natural components beyond our control. Due to this variance in material, all components will stain with colour or natural finish differently.

Iron pickets are wrought in nature and depending on the manufacturing process will have differences from picket to picket which is normal. Also the finish of the iron pickets is of a powder coated nature. This process can produce minor colour variations or tones. Furthermore, the assembly of the metal pickets can develop a natural rattle over time from vibration in the railing. Minor rattling is normal and is a part of the wrought iron picket assembly.

HOUSE EXTERIORS

Variations in subcontractors across different sites and varying site conditions may result in house exteriors that differ from the artist renderings. We cannot be responsible for results which differ from the artists renderings of elevations.

PLASTER MOULDINGS AND MEDALLIONS

Plaster mouldings will not be installed in open to above areas or areas with 2 storey elements.

STAIN COLOURS

Due to the many variables that can affect the outcome of a stain colour on wood, staircases, railings, and fireplaces, the colour may not be identical to samples. Factors such as density, age, humidity, air temperature, and the uniqueness of each piece of wood can result in wide variations in darkness or lightness. We will make every attempt to come as close to the sample as possible, but cannot be responsible for results which differ from the samples.

Stain on pre-finished hardwood floors will not be an exact match to the stain colours available on stairs, pickets and rails. The purchaser is responsible for choosing the stain on these areas to their satisfaction.

IN-WALL CONDUIT FOR AUDIO/VIDEO CABLES

It is important to note that due to the variation in framing requirements in different parts of your home, conduit lengths and routing can vary. In virtually all instances of ground floor installation (i.e. above a fireplace), conduit will first travel down into the basement below the floor joists, over to the termination point and back up into the main floor. As a result, it is best to measure the length of the conduit after occupancy with a "pull wire" before

BE2-137
September 11 2020.

see attach-

purchasing your cables. For above-fireplace installations, the conduit wall plate will be installed approximately 10" above the Fireplace Mantle, unless otherwise specified in the Construction Summary.

APPLIANCE SPECIFICATIONS

All appliance openings are set to builder's standard openings. Please advise Décor Centre at time of your structural appointment if custom sizing of cabinets is required for any built-in appliances. The purchaser is responsible for costs and fees associated with changes to pre-manufactured kitchens made subsequent to colour appointments.

Purchaser accepts & acknowledges that in order to accommodate upgraded appliances, all appliance specifications should be provided at the time of their structural appointment, should this not occur they must be provided to the Décor Center within one (1) week of completion of structural chart. Failure to do so may result in the need to revert to the standard appliance openings or in a delay in construction of your dwelling, as well as a cost of \$500 to re-open your structural file should changes be required. As a result we may be forced to extend the closing of your transaction. Due to failure to complete the above-mentioned selections and at no fault of our own, we reserve our right to hold you responsible for this delayed closing, including charging extra administration cost and interest on the balance due on closing.

Purchasers Accept Standard Appliance Openings (unless otherwise specified):

Fridge - 37-1/2"W x 73-1/2" High Approx.

Range - 30-1/2"D x 31-1/2"W Approx.

Dishwasher - 24" W Approx.

DELETION OF HOODFAN & CABINETS ABOVE STOVE:

The purchasers are aware that in requesting NOT TO INSTALL builder's standard hood fan and standard cabinets above stove they will receive NO STANDARD HOOD FAN and NO CREDIT. Purchasers are installing their own hood fan after closing and accept that it may waive any warranty associated with such a change.

Purchasers accept and acknowledge that the exhaust fan duct hole may be off-centered with the stove in the kitchen due to purchasers installing their own hood fan after closing. The vendor is exempt from adjusting such openings for the purchasers range hood.

ELECTRICAL FOR APPLIANCES

Pricing is subject to change based on the appliance specifications provided. Purchasers should provide proper appliance specifications and cut-out sheets in order for Gold Park to price extras accordingly.

KITCHEN CABINETS

The kitchen you order/purchase will undoubtedly contain slight colour variations. The degree of these variations is virtually impossible to determine before the kitchen is installed in its intended location. The amount of and type of lighting will also affect various highlights in the finish. Note: No two pieces of wood are identical. Variations in colour tone and grain patterns make a perfect colour match virtually impossible. It is generally agreed that these variations add to the natural beauty of a wood kitchen.

STAIN

Charcoal is a spray stain applied to Oak and Maple products with several characteristics that are important to be aware of when purchasing this product.

1. Shadow lines may be visible at the interior profile edges of a door or drawer front. If movement occurs shadow lines may increase or decrease, depending on the style and/or size of a door or drawer front.
2. Variation and unevenness may be visible in the finish.
3. Hairline cracks at the joints are created over time due to the nature of natural wood, caused by usage, humidity**, or dryness. They tend to be more visible to darker stains, than lighter wood stains.

** Relative humidity is recommended to be between 45% and 55%. Please refer to Cortina Kitchens "Cleaning, Care, Maintenance, & Warranty Information" guide.

Please be advised that Cortina Kitchens will not replace doors and/or parts that exhibit the above characteristics associated with this finish. These characteristics are not avoidable and are a result of the natural characteristics of wood and wood veneer, and the characteristics of darker stains on wood. The Charcoal stain is not available on doors in Group IV, Group IVA, Group V and Group VA.

Cortina Kitchens offers a wide variety of finishes, applied to oak and maple products. The subject finishes include the spray stains Cocoa, Espresso, Graphite as well as wiping stain Ebony.

Due to the very dark stains applied on natural maple and oak doors and joints, several characteristics are important to be noted when purchasing these products.

1. Shadow lines may be visible at the interior profile edges of a door or drawer front. If movement occurs shadow lines may increase or decrease, depending on the style and/or size of a door or drawer front.
2. Variation and unevenness may be visible in the finish.
3. Hairline cracks at the joints are created over time due to the nature of natural wood, caused by usage, humidity, or dryness. They tend to be more visible to darker stains, than lighter wood stains.

Please be advised that Cortina Kitchens will not replace doors nor parts that exhibit the above characteristics associated with this finish. These characteristics are not avoidable and are a result of the natural characteristics of wood and wood veneer, and the characteristics of darker stains on wood.

EEA-137

September 11, 2020.

* See attach *

CABINETRY DOOR HARDWARE

Cortina Kitchens' cabinetry doors and drawer fronts will be drilled to accept a standard knob or handle selected from Cortina's hardware boards. This drilling comes standard with the order, and is done ONLY in our shop, not on the job site.

For those not wanting Cortina's hardware drilling, the following applies:

No holes to be drilled on the doors and drawer fronts should be specified in writing on the colour chart and the P.O. If while in production, Cortina Kitchens misses this request, Cortina Kitchens and the Builder will not be held responsible to replace any or all doors and drawer fronts affected, and the customer agrees to accept the product as is. No hardware will be supplied or credited by Cortina Kitchens with this request. No charge will apply for this request.

PVC DOORS

All cabinets with PVC (Thermofoil) Doors come with melamine gables, panels and kick. The doors, crown moulding and light valance are PVC wrapped. Open shelves incorporated in design will only be available with melamine interiors. There will be variations in colour shades between the PVC parts (doors, crown and light valance) and the melamine parts (open shelves, Gables, Panels and Kick) due to the difference in material.

Furring Panel with crown moulding to the ceiling is not available on all PVC door styles due to subtle variations in colour shades between the PVC parts (moulding) and the melamine parts (furring panel) due to the difference in material. Grain directions in wood grain pattern melamine, vary between the furring panel, crown moulding (horizontal) and the PVC doors (vertical).

GRANITE, MARBLE ENGINEERED SURFACES WAIVER

Granite and marble are naturally occurring products, and due to the many variables that can affect the pattern, colour and/or design and "pitting" of natural products slabs installed will not be identical to the samples displayed. We will make every attempt to come as close to the samples as possible, but cannot be responsible for results which differ from the samples. Every effort is made to provide granite counter tops as close as possible but the vendor is not responsible for results which differ from the sample displayed. All countertop surfaces may have seams & product pattern & shade can change in areas containing seams.

RESELECTIONS

It is not uncommon for flooring, such as tile, to become discontinued prior to its installation. Therefore it may be necessary to make a reselection of certain materials sometime during the build process. We cannot assure you that another choice approximating your selection will be available.

PLANS

Plans are subject to change without notice. Actual usable floor space may vary from the stated floor area. Layout for kitchen, furnace, HWT and laundry tub may vary from plan. Vertical and horizontal bulkhead, which are not shown on plan, may be required for plumbing and heating runs. E.& O.E.

PLEASE NOTE:

In the event the work on the house has progressed beyond the point where the items covered by these invoices cannot be installed without entailing any unusual expense, then this order is to be cancelled and any deposit paid in connection with the same is to be refunded to the purchaser.

The vendor will undertake to incorporate the work covered by the sales extra in the construction of the house but will not be liable to the purchaser in any way, if for any reason the work covered by the extra is not carried out. In that event, any monies paid in connection with the same shall be returned to the purchaser.

It is understood and agreed that if for any reason whatsoever the transaction of Purchase and Sale is not completed, the total cost of extras ordered are not refundable to the Purchaser(s).

Extras or changes will not be processed unless signed by the Vendor.

These extras may not be amended without the written consent of Gold Park Homes.

The purchaser(s) and the builder acknowledge and agree that this "Purchaser's Extra" form shall not be deemed to be part of the agreement of purchase and sale entered into between them, nor an addendum thereto.

No postdated cheques will be accepted.

No estimates or orders will be accepted once construction has commenced.

Should a refund be requested on any extras purchased, an 80% reimbursement of the purchase price will be given. (a \$50.00 minimum charge and a maximum \$250.00 charge will apply)

Estimates will only be considered when resubmitted on a signed Purchaser Extras form, accompanied by payment in full.

All prices are estimates only and may be subject to change. Should a change in price occur Gold Park Homes reserves the right to request from the purchaser an adjustment of the price or a refund limited to that item.

Purchasers are aware & accept that ANY changes made to upgrades after signing the Purchasers Extra Form are subject to a minimum administration fee of \$500. PLUS a 10% holdback fee.

Purchasers are aware that any request to add a percentage of upgrades from the purchaser's extras form will be processed only after the builder receives approval letter from the bank.

BE2-137 September 11, 2020

* see attach *

Please be advised that your failure to finalize your structural or colour selections may result in a delay in construction of your dwelling and we may have to extend closing of your transaction. Due to failure to complete the above-mentioned selections and at no fault of us, we reserve our right to hold you responsible for a delayed closing, including charging extra administration cost and interest on the balance due on closing.

Purchaser has attended a Colour appointment at the Decor Centre & has DECLINED any additional upgrades and accepts and acknowledges that there will be no further structural changes/additions/deletions to be made upon signing.

I hereby acknowledge reading and understanding the above copy and will not hold Gold Park Homes responsible for any issues in relation to above.

** see attach **

Purchasers Signatures

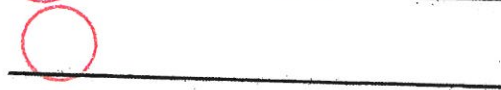
Date September 11 2020

BE2-137

AVG

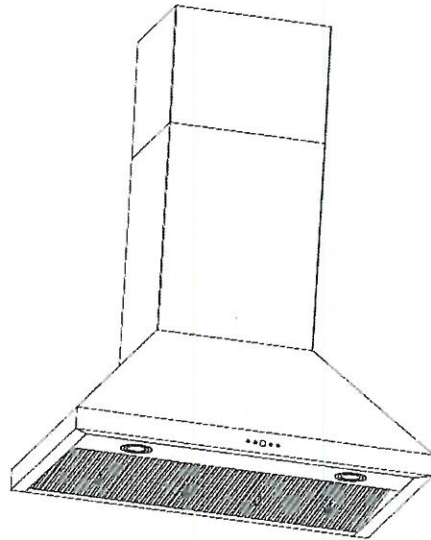

see attached

BE2-137

Nov. 3, 2020

Hotte murale / Wall mounted range hood

Modèle / Model: **AVO-308CS & AVO-368CS – OREGON**

INSTRUCTIONS D'INSTALLATION ET GUIDE DE L'USAGER INSTALLATION GUIDE / USE AND CARE MANUAL

IMPORTANT: Lire et conserver ces instructions. *Read and save these instructions.*

Installateur: Laissez ce manuel au propriétaire. **Propriétaire:** Conservez ce guide pour référence ultérieure.

Installer: Leave this manual with the homeowner. **Homeowner:** Keep this guide for future reference.

R120919NP



Dimensions

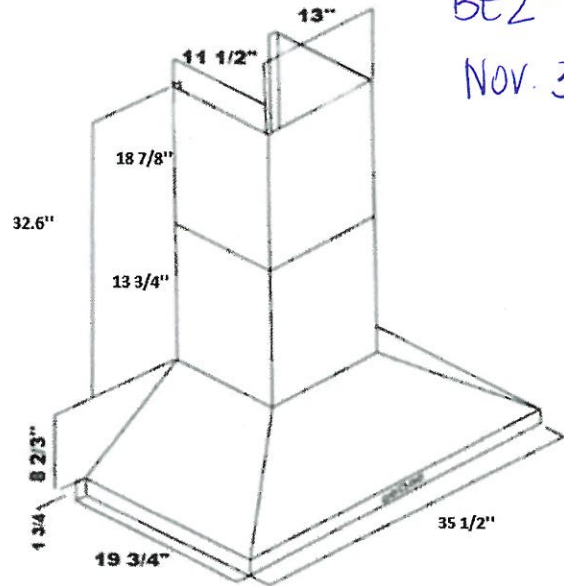
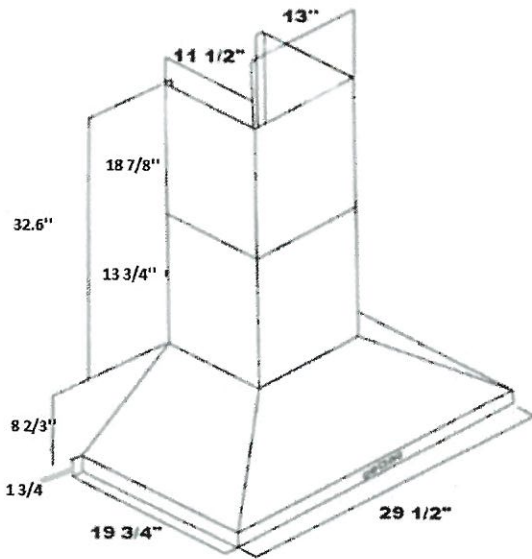

~~*see attached*~~
 BE2-137
 Nov. 3, 2020

Installation

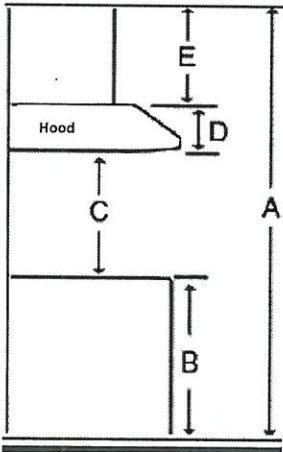

A	Floor to ceiling height	VARIABLE
B	Floor to counter top height (standard)	36"
C	Recommended height between cooking surface and bottom of the hood	28" to 30"
D	Hood height	10.41"
E	Chimney height	13 3/4" to 32 7/8"

Duct transition

6" top round

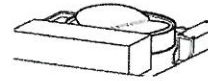

The information contained herein is based on sources that we believe to be reliable, but is not guaranteed by us, may be incomplete and/or may change without notice.